

SSSA130I

28.09.2021

Key-operated switch, maintained



General Data

Type reference	SSSA130I
Description	Key switch with integrated contact block
Approvals	CCC, CE, cURus, DNV, ENEC10, VDE, UKCA
Contact type	1 NC + 1 NO
Degree of protection	IP65
Connection type	Faston terminals 2.8 x 0.8 mm
Contact material	AgNi
Max. storage temperature	-40°C ... 80°C
Max. operating temperature	-25°C ... 70°C
Mechanical life	30,000 switching cycles
Electrical life (rated load)	30,000 switching cycles at rated load
Contact resistance NO	< 20 mOhm
Contact resistance NC	< 20 mOhm
Min. current	1 mA (under laboratory conditions)
Min. voltage	5 V
Bouncing time NO	< 10ms
Bouncing time NC	< 10ms
Positive opening contact	acc. to EN60947-5-1, appendix K

Electrical data acc. to IEC/EN 60947-5-1 (VDE 0660 Sect. 200)

	alternate current	direct current
Utilisation category	AC15 B300	DC13 Q300
Rated insulation voltage U_i	250 V	250 V
Rated operating voltage U_e	240 V / 120 V	250 V / 125 V / 60 V / 24 V
Rated operating current I_e	1.5 A / 3 A	0.27 A / 0.55 A / 1 A / 2 A
Breaking capacity	10 I_e	1,1 I_e
Continuous thermal current	5 A	-

Electrical data acc. to IEC/EN 61058-1 (VDE 0630 Sect. 1)



Rated voltage U _e	250 V~
Rated current I _e	6(4) A

Additional data

Mounting aperture	22.3 mm
Tightening torque (mounting nut)	1.5 ... 1.9 Nm
Mounting position	any
Standards	EN 60947-5-1, EN 61058-1
Material group	I
Overvoltage category	II
Pollution degree	2

Note

O = NC contact; I= NO contact

- silver-coloured front ring

DC13: 30.000 switching cycles

Versions with Faston terminals: use partially or all-insulated Faston clamps

Data acc. to UL508

Rating	Pilot duty B300; 24 V dc/3 A
--------	------------------------------



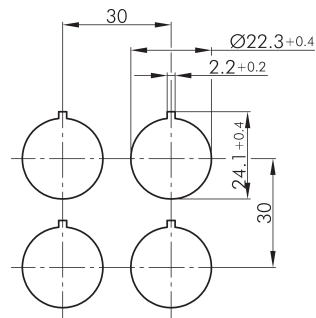
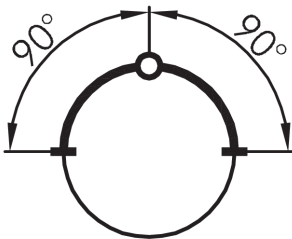
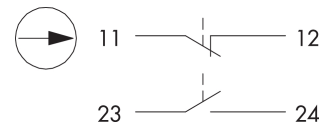
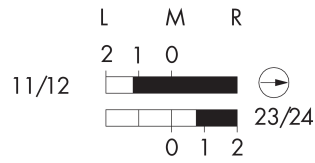

Légende:
I=Position de commutation >=Rappel par ressort O=Retrait de la clé

Légende:
I= Schaltstellung >= Federrückzug O= Schlüsselabzugstellung

Legend:
I= Switching position >= Spring return O= Key removable position

